

Number Bonds to 20 Dominoes

Instructions:

To play the game you need to match one domino to another, making sure they total 20.

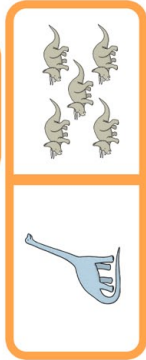
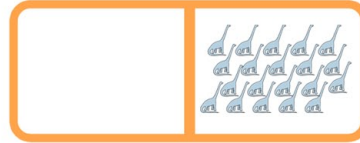

twinkl.co.uk

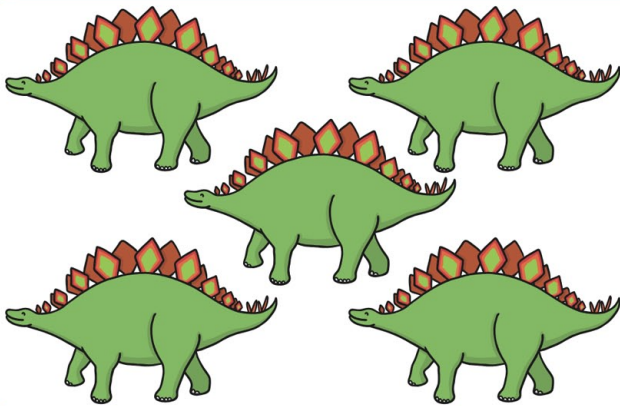

twinkl.co.uk

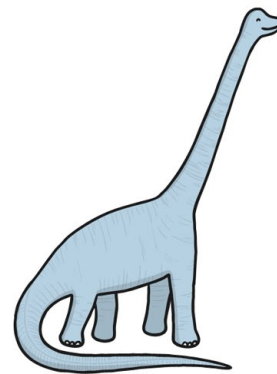
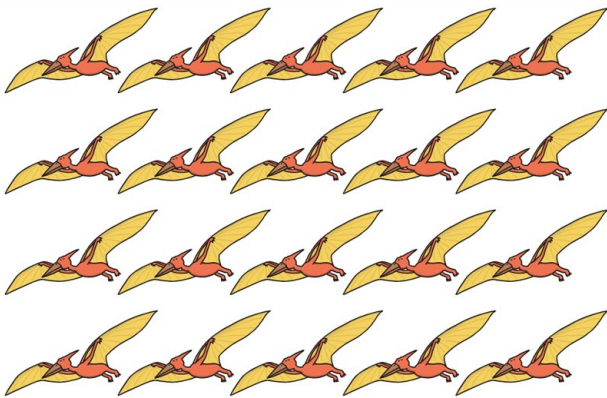

twinkl.co.uk

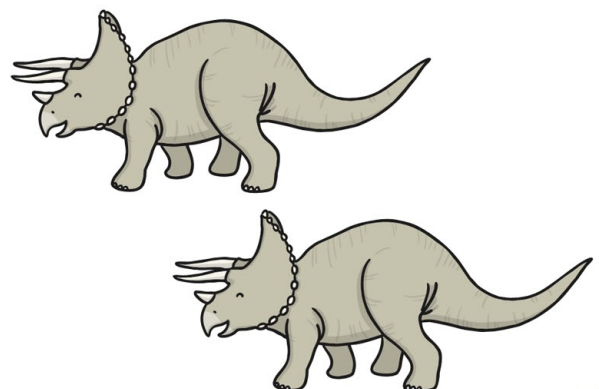
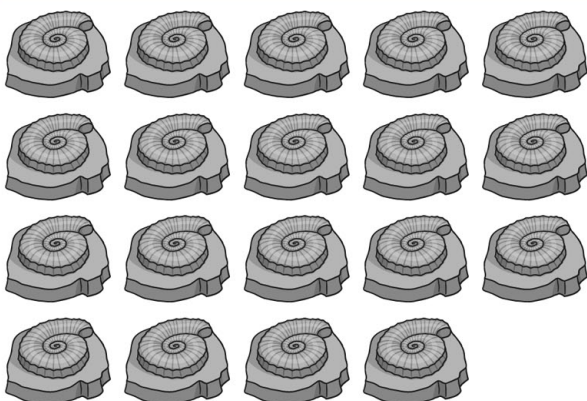

twinkl.co.uk

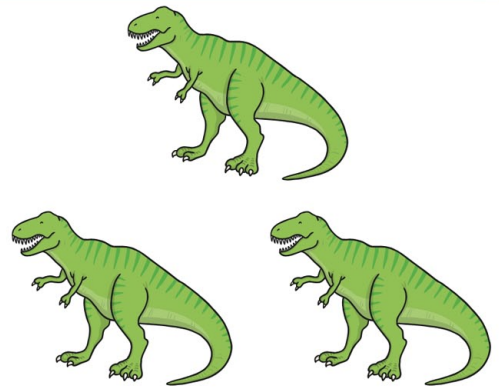
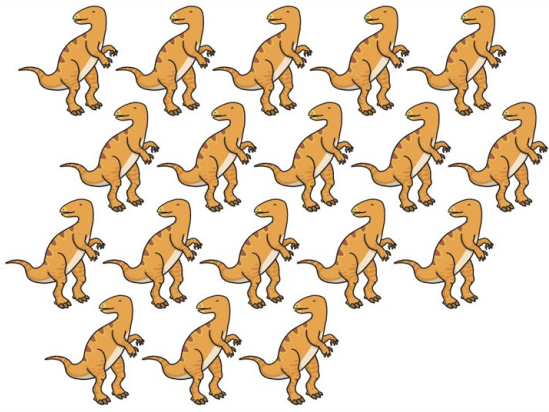

twinkl.co.uk

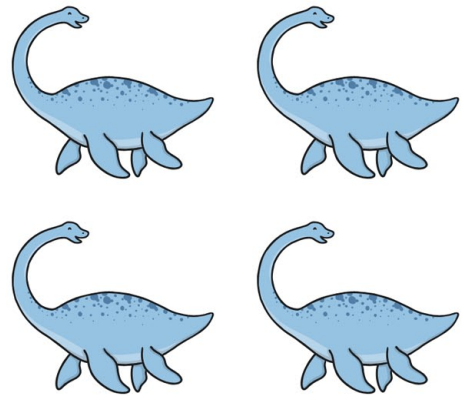
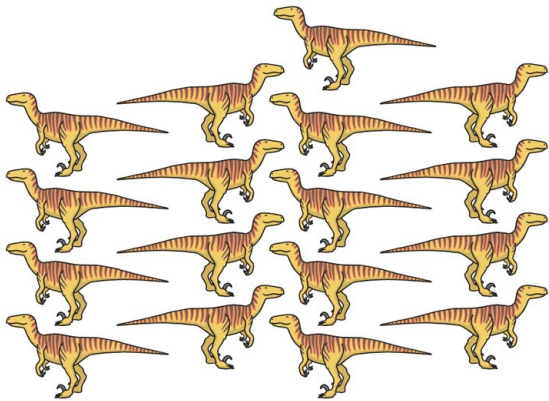

twinkl.co.uk

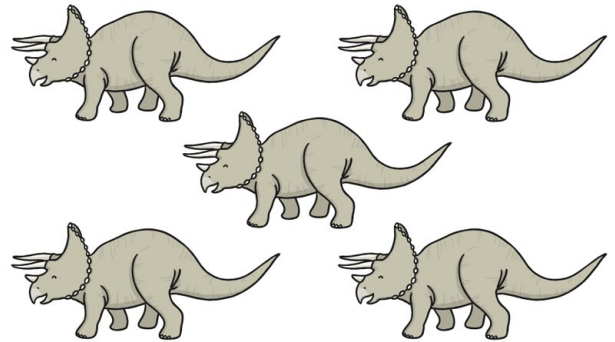
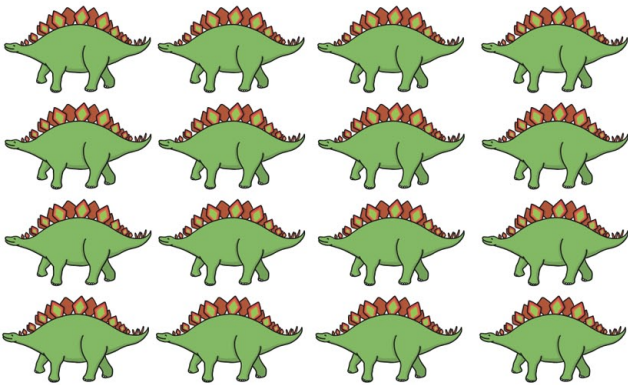

twinkl.co.uk

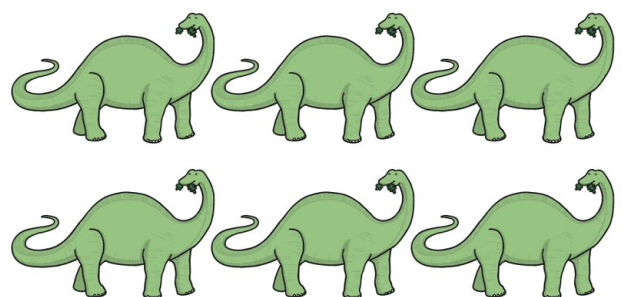
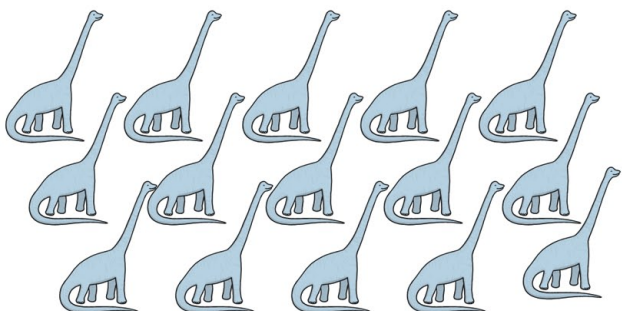

twinkl.co.uk

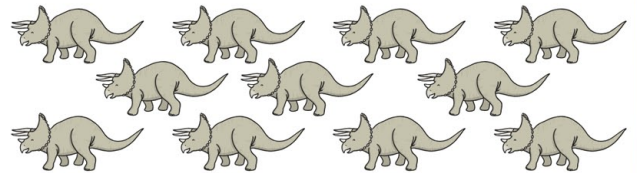
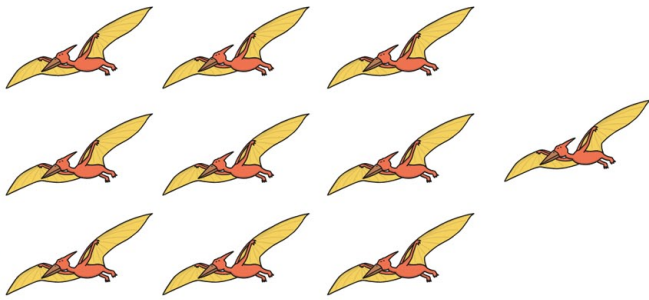

twinkl.co.uk

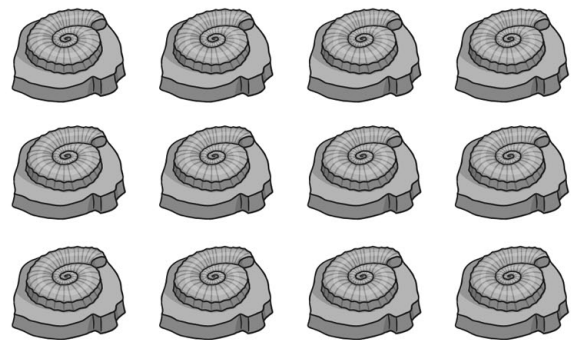
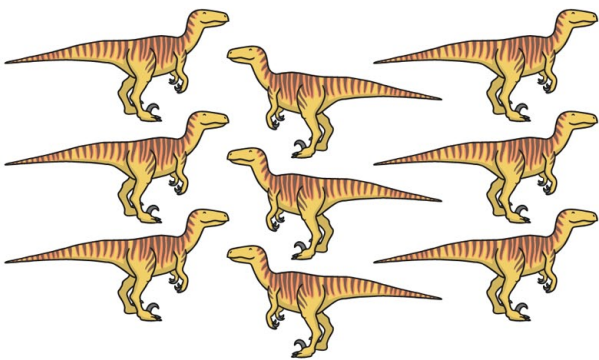

twinkl.co.uk

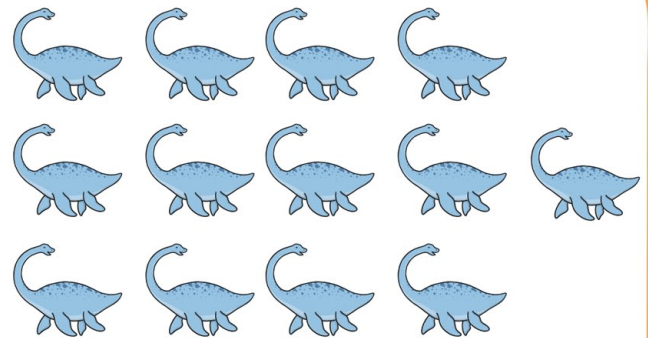
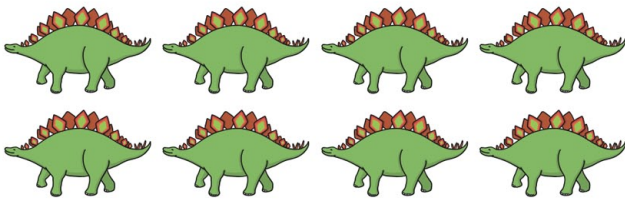

twinkl.co.uk

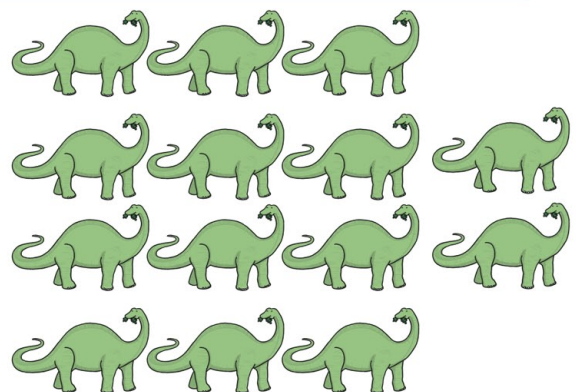
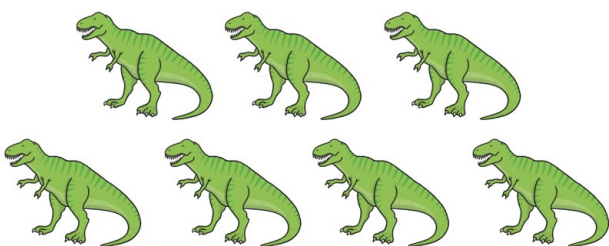

twinkl.co.uk

